

Ex-plugs and receptacles 32 A 4/5-pole up to 690 V



Wall socket



Flange socket



Coupler



Plug

Technical data

Ex-plugs and receptacles acc. to IEC 60309-1/2

Marking accd. to 2014/34/EU	Ⓔ II 2 G Ex de (ia) IIC T6 / Ⓔ II 2 D Ex tD A21 IP66 T80 °C
EC-Type Examination Certificate	Wall socket, plug and coupler: PTB 99 ATEX 1041 Flange socket: PTB 99 ATEX 1042 U
IECEX Certificate of Conformity	IECEX BK1 04.0006
Marking accd. to IECEx	Ex ed [ia] IIC T6/T5
Permissible ambient temperature	-20 °C to +40 °C ¹⁾
Rated voltage	up to 690 V (AC)
Rated current	32 A
Frequency	up to 400 Hz
Rated making / Rated breaking capacity AC-3 accd. EN 60947-3	U_b 690 V / I_b 32 A
External back up fuse	without therm. protection: 35 A with therm. protection: 50 A gG (rated current 32 A set to)
Protection class	I
Degree of protection accd. to EN 60529	IP66
Enclosure colour	black

Wall socket

Cable entry/enclosure drilling	1 x M40 cable gland, 1 x M40 plastic Ex-screw plug or 2 x M32 metal thread with 2 plastic Ex-screw plug
Connecting terminals	2 x 4 - 10 mm ²
Enclosure material	glass-fibre reinforced polyester

Plug

Cable entry	Ø 12 - 28 mm
Connecting terminals	1.0 - 6 mm ²
Enclosure material	Polyamide

Coupler

Cable entry	Ø 12 - 28 mm
Connecting terminals	2 x 4 - 10 mm ²
Enclosure material	Polyamide

Flange socket

Connecting terminals	2 x 4 - 10 mm ²
Enclosure material	Polyamide

¹⁾ extended temperature range on request

Details for used cable glands see pages 2.3.ff

Ex-plugs and receptacles 32 A 4/5-pole up to 690 V



Plug



Coupler







Flange socket



Wall socket

Ordering details

Voltage	h	Type	Aux. contact	Cable entry	Weight approx.	Order No.
Type 32 A 4-pole						
200-250 V		Wall socket	–	KU	2.3 kg	GHG 512 4409 R0001
		Wall socket	–	ME	2.4 kg	GHG 512 4409 R3001
		Wall socket	–	GM	2.3 kg	GHG 512 4409 R3003
		Flange socket			1.0 kg	GHG 512 8409 R0001
		Coupler			1.55 kg	GHG 512 3409 R0001
		Plug			0.55 kg	GHG 512 7409 R0001
380-415 V		Wall socket	–	KU	2.3 kg	GHG 512 4406 R0001
		Wall socket	–	ME	2.4 kg	GHG 512 4406 R3001
		Wall socket	yes	KH	2.3 kg	GHG 512 4406 R0501
		Wall socket	–	GM	2.4 kg	GHG 512 4406 R3003
		Flange socket			1.0 kg	GHG 512 8406 R0001
		Coupler			1.55 kg	GHG 512 3406 R0001
480-500 V		Wall socket	–	KU	2.3 kg	GHG 512 4407 R0001
		Wall socket	–	ME	2.4 kg	GHG 512 4407 R3001
		Wall socket	yes	KH	2.3 kg	GHG 512 4407 R0501
		Flange socket			1.0 kg	GHG 512 8407 R0001
		Coupler			1.55 kg	GHG 512 3407 R0001
		Plug			0.55 kg	GHG 512 7407 R0001
600-690 V		Wall socket	–	KU	1.8 kg	GHG 512 4405 R0001
		Wall socket	–	ME	2.4 kg	GHG 512 4405 R3001
		Wall socket	yes	KH	2.3 kg	GHG 512 4405 R0501
		Flange socket			1.0 kg	GHG 512 8405 R0001
		Coupler			1.55 kg	GHG 512 3405 R0001
		Plug			0.55 kg	GHG 512 7405 R0001
Type 32 A 5-pole						
200-250 V 380-415 V		Wall socket	–	KU	2.3 kg	GHG 512 4506 R0001
		Wall socket	–	ME	2.4 kg	GHG 512 4506 R3001
		Wall socket	yes	KH	2.3 kg	GHG 512 4506 R0501
		Wall socket	–	GM	2.4 kg	GHG 512 4506 R3003
		Flange socket			1.0 kg	GHG 512 8506 R0001
		Coupler			1.6 kg	GHG 512 3506 R0001
		Plug			0.6 kg	GHG 512 7506 R0001

Other voltage ranges and versions available on request

KU = 1 x plastic cable glands M40, 1 x M40 plastic Ex-screw plug

KH = 1 x plastic cable glands M40, 1 x plastic cable glands M25, with aux. contact

ME = 2 x metal thread M32 with plastic Ex-screw plug

GM = 2 x metal thread M32 with screw plug, with external earth bolt M6

Ex-plugs and receptacles 32 A 4/5-pole up to 690 V

1



Wall socket



Flange socket



Coupler



Plug

Dimension drawing | Wiring diagram

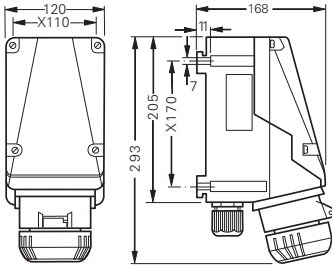

Wall socket 4-pole

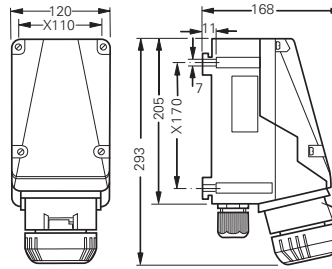

Wall socket 5-pole

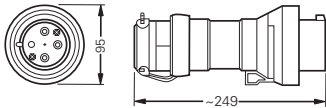

Plug 4-pole

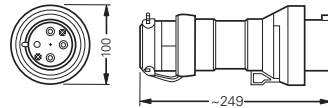

Plug 5-pole

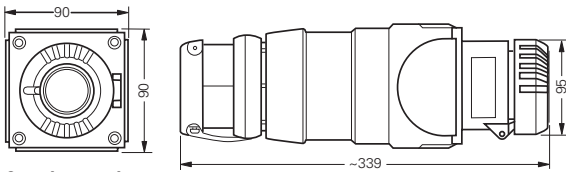

Coupler 4-pole

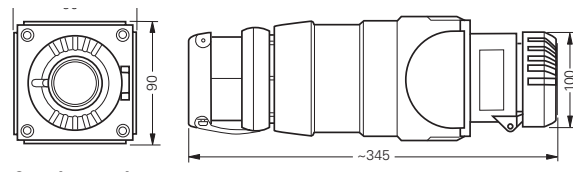

Coupler 5-pole

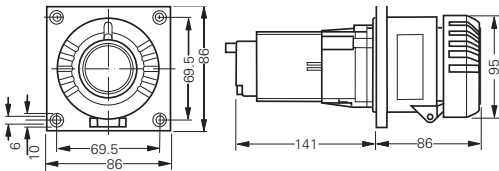

Flange socket 4-pole

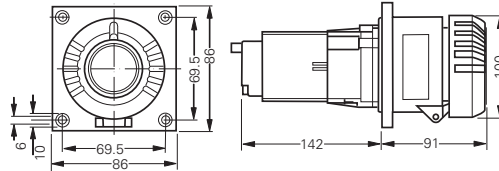

Flange socket 5-pole

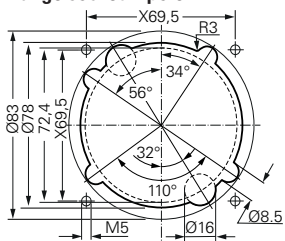

Assembly dimensions flange socket

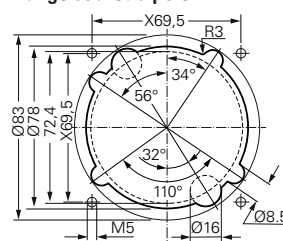

Assembly dimensions flange socket

X = fixing dimensions

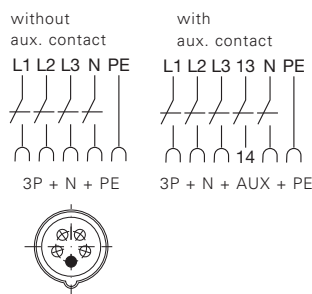
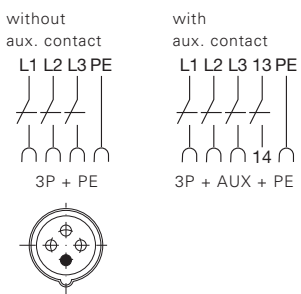

Dimensions in mm



Protective canopy



Plug cap



GHG 610 1901 R0128

Accessories

Type	Application	Fixing method	Order No.
Mounting plates for wall sockets 32 A			
Size 5	for wall mounting	snap on	GHG 610 1953 R0128
Size 5	for trellis mounting	snap on	GHG 610 1953 R0128
Size 5	for pipe clamp	snap on	GHG 610 1953 R0132

Type	Order No.
------	-----------

Plug cap for plugs 32 A

Plug 32 A 3-pole/4-pole	GHG 510 1901 R0004
Plug 32 A 5-pole	GHG 510 1901 R0005

Type	OU	Order No.
------	----	-----------

Accessories for mounting plates

Mounting set for pipes 1" (Ø 27 - 30 mm) for mounting plates with pipe fixing	10	GHG 610 1953 R0020
---	----	--------------------

Please pay attention that only order units (OU) according to the ordering details can be delivered.

Type	Application	Order No.
------	-------------	-----------

Protective canopy for mounting plate

Size 5	for mounting plate size 5, snap on	GHG 610 1955 R0108
--------	------------------------------------	--------------------

Dimension drawing

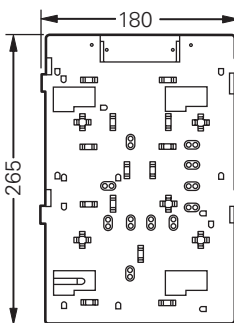

Mounting plate size 5 for wall/trellis mounting

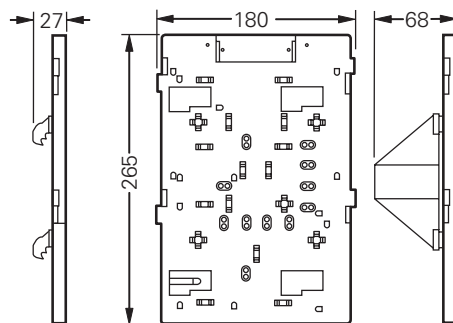

Mounting plate size 5 for pipe mounting

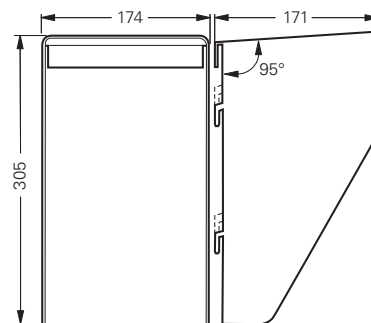

Protective canopy size 5